

AN ISO CERTIFIED COMPANY



FINEST IN STYLE
STRONGEST IN SECURITY

CENT

C

CENT

Since 1992

When you are looking for the ultimate in luxury
"Yes, they will easily handle
even envy for you"

WELCOME TO THE CENT PRODUCT CATALOGUE...

Your comprehensive guide
to all of our manufacturing,
product ranges, finishes and standards.

WHO WE ARE

We are designers and suppliers of top quality architectural door hardware including door handles, knobs, locks and more.

Every item is selected for its quality and value for money, and we are confident in our belief that we can offer some of the highest quality products at the most competitive prices.



Meet The Owner



NEERAJ MAHESHWARI

FOUNDER & OWNER

EDUCATION

B.Com, DS College, Aligarh
M.Com, Varshney College, Aligarh
LLB, Varshney College, Aligarh

Founder & Owner at Cent Metal Industries | Leading Locks and Hardware Manufacturer | Driving Quality and Innovation in the Industry

Cent Metal Industries: Your trusted source for top-quality locks and hardware solutions. As the Founder & Owner, I am dedicated to delivering excellence through innovative products and exceptional customer service. Connect with me to explore our comprehensive range of secure and reliable solutions. Let's create secure spaces together.



TANMAY MAHESHWARI

MANAGING DIRECTOR

EDUCATION

Global MBA, University of South Wales, Cardiff
Post Graduate Program in Management, Lexicon MILE, Pune
Bachelor's in business administration, GGSIPU, Delhi

Embracing Family Legacy | Driving Growth and Transformation at Cent Metal Industries

Business professional with 3 years of experience. Passionate about driving impact and achieving success. Skilled in Business Development, Entrepreneurship, Sales and Marketing. Dedicated to upholding family legacy while fostering growth and transformation at Cent Metal Industries. Committed to continuous learning, collaboration, and delivering exceptional results. Let's connect and shape a better future together!



CONTENT

DOOR KIT SERIES -----

- ZINC DOOR KIT 01 - 11
- BRASS DOOR KIT 12 - 26

MORTISE HANDLE SERIES -----

- BRASS MORTISE HANDLE 27 - 40
- ZINC & SS MORTISE HANDLE 41 - 46
- ALUMINIUM MORTISE HANDLE 47
- MS MORTISE HANDLE 48
- SS 202G. MORTISE HANDLE 49

DOOR HANDLE SERIES -----

- BRASS PULL HANDLE 50 - 54
- BRASS SECTION PULL HANDLE 55 - 57
- BRASS DOUBLE DOOR HANDLE 58 - 60
- BRASS CABINET HANDLE 61 - 62
- SS PULL HANDLE 63 - 64

LOCK SERIES -----

- KY MORTISE LOCK 65 - 66
- CY MORTISE LOCK 67
- BRASS CYLINDER 68
- MULTIPURPOSE LOCK 69
- DOOR LOCK 70 - 73

OTHER ITEM SERIES -----

- BRASS DOOR KNOCKERS 74 - 75
- BRASS WALL ORNAMENTS 76
- BRASS KNOBS 77
- BRASS DOMES 78
- TOWER BOLTS 79
- BRASS MANICHITRAM 80



Salt Spray Test 96 Hours



Lacquer Rub Test 2500+



Regular Customer Meet



Nickle Plating 16 Micron Above

ZINC DOOR KITS

The patterns that the surf of the sea draw on the shoreline characterize the unusual form of this collection with a particularly modern and evocative design.

MADE IN INDIA

CENT
AN ISO CERTIFIED COMPANY



**REACH
THE UNREACHABLE**

COMET



Aldrop



Latch
12mm



MATERIAL
Zinc



ROD THICKNESS
12 & 16mm



FINISH
SS, Ant, Black



FUNCTION
Indoor & Outdoor

Door Thickness : 37mm upto 80mm
Application : Hotel, Residential, Office
Suitable for : Wooden main doors



Stopper
125mm



Handle
175mm



Con. Handle
200, 250mm

KIA



Aldrop



MATERIAL
Zinc



ROD THICKNESS
12 & 16mm



FINISH
SS & Antique



FUNCTION
Indoor & Outdoor

Door Thickness : 37mm upto 80mm
Application : Hotel, Residential, Office
Suitable for : Wooden main doors



Latch
12mm



Stopper
125mm



Handle
150, 175mm



Con. Handle
200, 300mm

ROMAN



Aldrop



Latch
12mm

 MATERIAL
Zinc

 ROD THICKNESS
12, 16 & 19mm

 FINISH
SS & Antique

 FUNCTION
Indoor & Outdoor

Door Thickness : 37mm upto 80mm
Application : Hotel, Residential, Office
Suitable for : Wooden main doors



Stopper
125mm



Handle
100, 125, 150mm



Con. Handle
200, 250mm

INDIAN



MATERIAL
Zinc



ROD THICKNESS
12 & 16mm



FINISH
SS & Antique



FUNCTION
Indoor & Outdoor

Door Thickness : 37mm upto 80mm
Application : Hotel, Residential, Office
Suitable for : Wooden main doors



ONLINE



MATERIAL
Zinc



ROD THICKNESS
12 & 16mm



FINISH
SS & Antique



FUNCTION
Indoor & Outdoor

Door Thickness : 37mm upto 80mm
Application : Hotel, Residential, Office
Suitable for : Wooden main doors



STYLE



MATERIAL
Zinc

ROD THICKNESS
12 & 16mm

FINISH
SS & Antique

FUNCTION
Indoor & Outdoor

Door Thickness : 37mm upto 80mm
Application : Hotel, Residential, Office
Suitable for : Wooden main doors



UNIX



MATERIAL
Zinc



ROD THICKNESS
12 & 16mm



FINISH
SS & Antique



FUNCTION
Indoor & Outdoor

Door Thickness : 37mm upto 80mm
Application : Hotel, Residential, Office
Suitable for : Wooden main doors



MOON



 MATERIAL
Zinc

 ROD THICKNESS
12 & 16mm

 FINISH
SS & Antique

 FUNCTION
Indoor & Outdoor

Door Thickness : 37mm upto 80mm
Application : Hotel, Residential, Office
Suitable for : Wooden main doors



FREYA

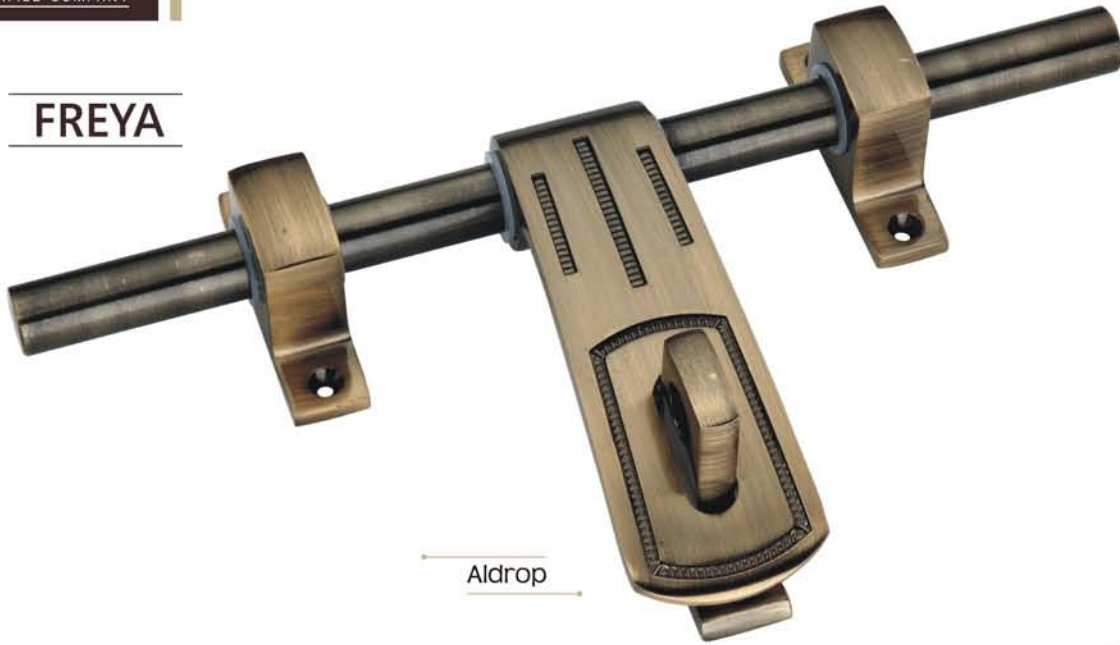

Aldrop

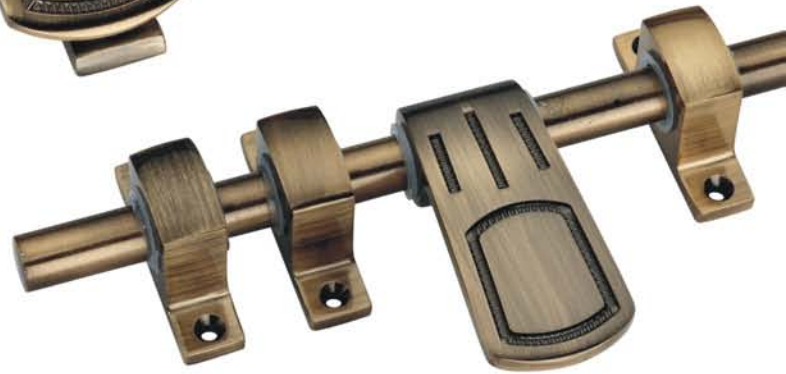

Latch
12mm

 MATERIAL
Zinc

 ROD THICKNESS
16mm

 FINISH
SS & Antique

 FUNCTION
Indoor & Outdoor

Door Thickness : 37mm upto 80mm
Application : Hotel, Residential, Office
Suitable for : Wooden main doors



Stopper
125mm



Handle
175mm



Con. Handle
200, 250mm

KUSHAQ



Aldrop



MATERIAL
Zinc



ROD THICKNESS
16mm



FINISH
SS, Ant. & Black



FUNCTION
Indoor & Outdoor



Latch
12mm

Door Thickness : 37mm upto 80mm
Application : Hotel, Residential, Office
Suitable for : Wooden main doors



Stopper
125mm



Handle
175mm



Con. Handle
200mm

BRASS DOOR KITS

New Brass Door Kits Designs for main doors unique in its kind, thanks to its multifaceted design, it can be easily combined in any environment.

MADE IN INDIA

CENT
AN ISO CERTIFIED COMPANY



BEST QUALITY
& **AFFORDABLE PRICE**



GLOSTER



Aldrop



Latch
12, 16mm

 MATERIAL
Brass

 ROD THICKNESS
AVL. IN SS ROD ONLY
12, 16 & 19mm

 FINISH
Antique

 FUNCTION
Indoor & Outdoor

Door Thickness : 37mm upto 80mm
Application : Hotel, Residential, Office
Suitable for : Wooden main doors



Stopper
125, 150mm



Handle
150, 175mm



Con. Handle
200, 250, 300mm

HECTOR



Aldrop

 MATERIAL
Brass

 ROD THICKNESS
AVL. IN SS ROD ONLY
12, 16 & 19mm

 FINISH
Antique

 FUNCTION
Indoor & Outdoor



Latch
12, 16mm

Door Thickness : 37mm upto 80mm
Application : Hotel, Residential, Office
Suitable for : Wooden main doors



Stopper
125, 150mm



Handle
150, 175mm



Con. Handle
200, 250, 300mm

NEXA



-  MATERIAL
Brass
-  ROD THICKNESS
12, 16 & 19mm
-  FINISH
BPL, Ant., SS



LAPIN



 MATERIAL
Brass

 ROD THICKNESS
12, 16 & 19mm

 FINISH
BPL, Ant., SS

Aldrop



Door Chain



Latch
12, 16mm



Stopper
125, 150mm







Handle
125, 150, 175mm

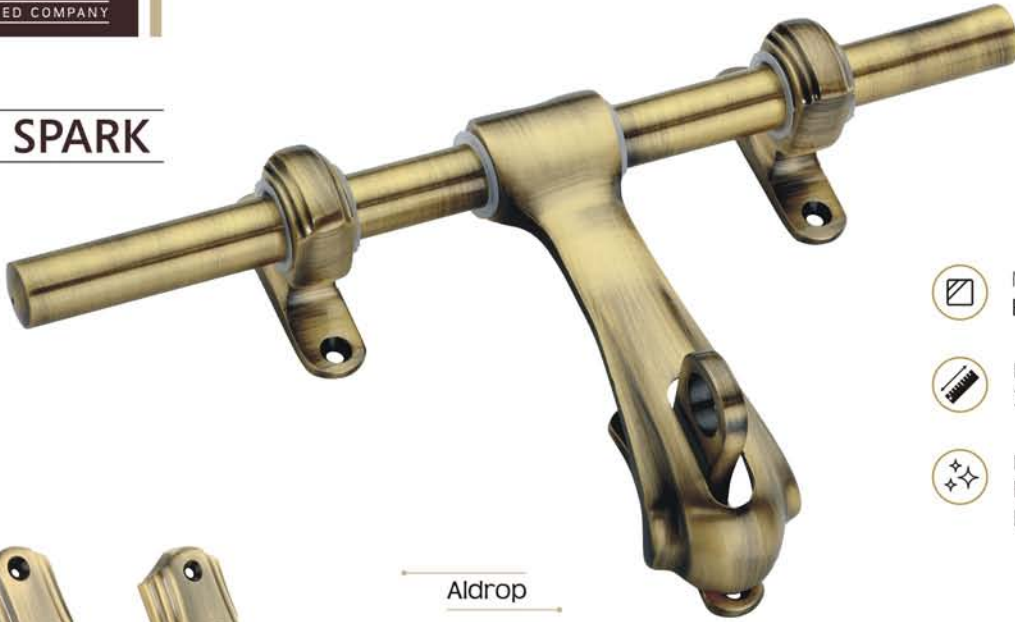

Con. Handle
200, 250, 300mm

SPARK



-  MATERIAL
Brass
-  ROD THICKNESS
12, 16 & 19mm
-  FINISH
BPL, Ant., SS
FSG

Aldrop



Door Chain

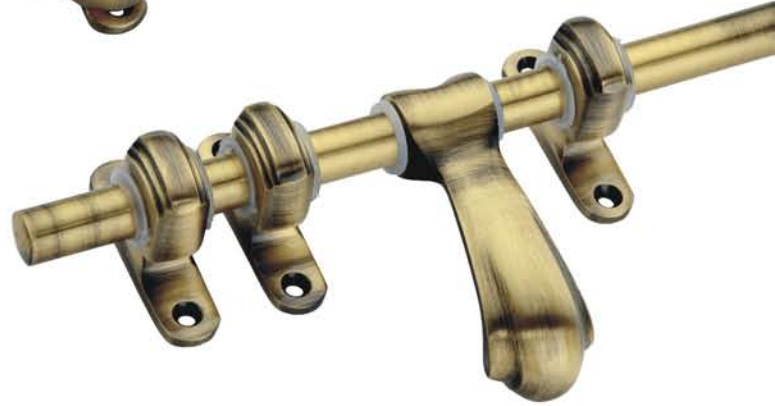

Latch
12mm



Stopper
125, 150mm





Handle
100, 125, 150, 175mm



Con. Handle
200, 250, 300mm

FISTA



-  MATERIAL
Brass
-  ROD THICKNESS
12, 16 & 19mm
-  FINISH
BPL, Ant., SS
FSG

Aldrop



Door Chain



Latch
12, 16mm



Stopper
125, 150mm



Handle
100, 125, 150, 175mm



Con. Handle
200, 250, 300mm

TUSKER



 MATERIAL
Forged Brass

 ROD THICKNESS
12, 16 & 19mm

 FINISH
BPL, Ant., SS
FSG

Aldrop



Door Chain



Latch
12mm



Stopper
125mm



Handle
100, 125, 150, 175mm



Con. Handle
200, 250mm

WAVE

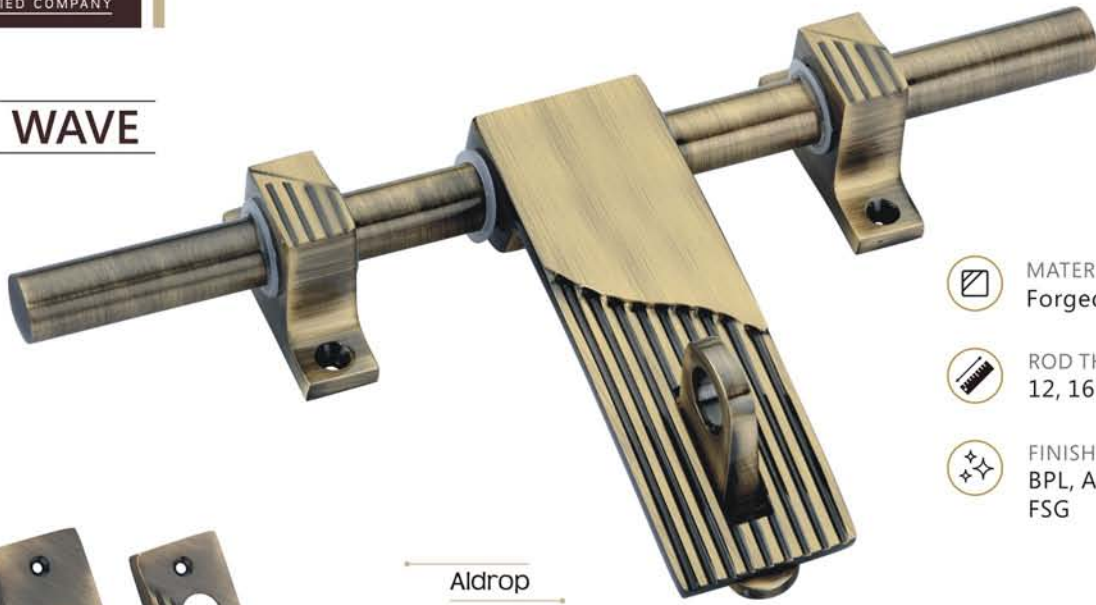

 MATERIAL
Forged Brass

 ROD THICKNESS
12, 16 & 19mm

 FINISH
BPL, Ant., SS
FSG

Aldrop



Door Chain

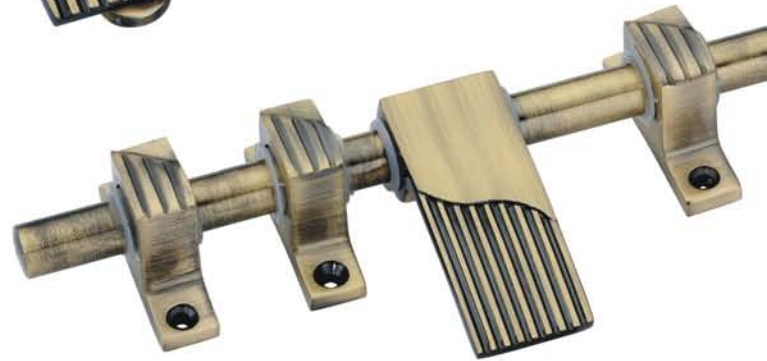

Latch
12, 16mm



Stopper
125mm





Handle
150mm



Con. Handle
200, 250, 300mm

MUGAL



-  MATERIAL
Brass
-  ROD THICKNESS
12, 16 & 19mm
-  FINISH
BPL, Ant., SS
FSG

Aldrop



Door Chain



Latch
12, 16mm



Stopper
125, 150mm



Handle
100, 125, 150, 175mm



Con. Handle
200, 250, 300mm

NERO

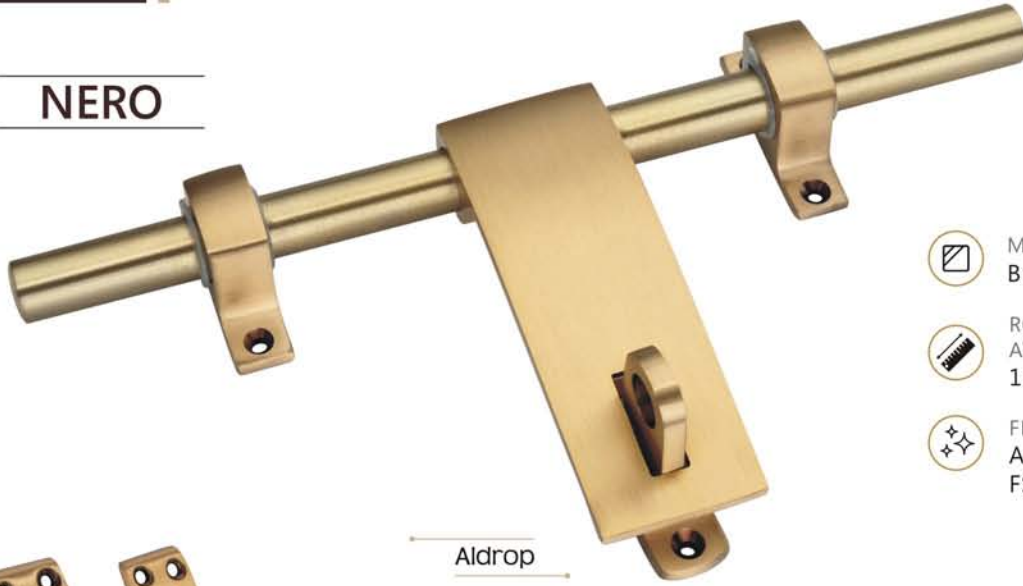

Aldrop

-  MATERIAL
Brass
-  ROD THICKNESS
AVL. IN SS ROD ONLY
12, 16mm
-  FINISH
Ant., SS, C.Ant.
FSG



Door Chain

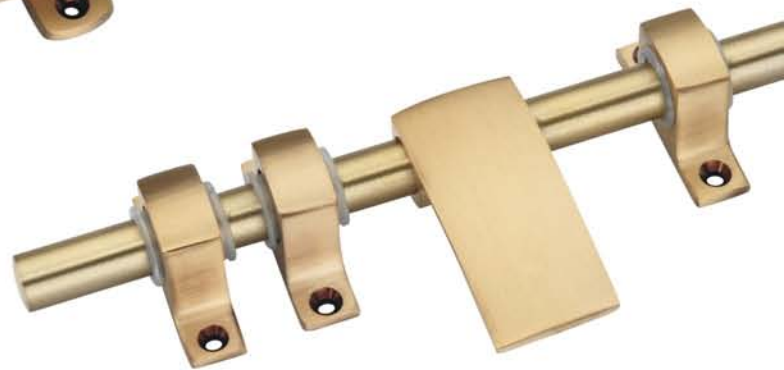

Latch
12mm



Stopper
125mm

Handle
175mm



Con. Handle
200, 250mm

NEO



-  MATERIAL
Brass
-  ROD THICKNESS
AVL. IN SS ROD ONLY
16mm
-  FINISH
Ant., SS, Black



Door Chain



Aldrop



Latch
12mm



Stopper
125mm

Handle
150mm



Con. Handle
200mm

STONE

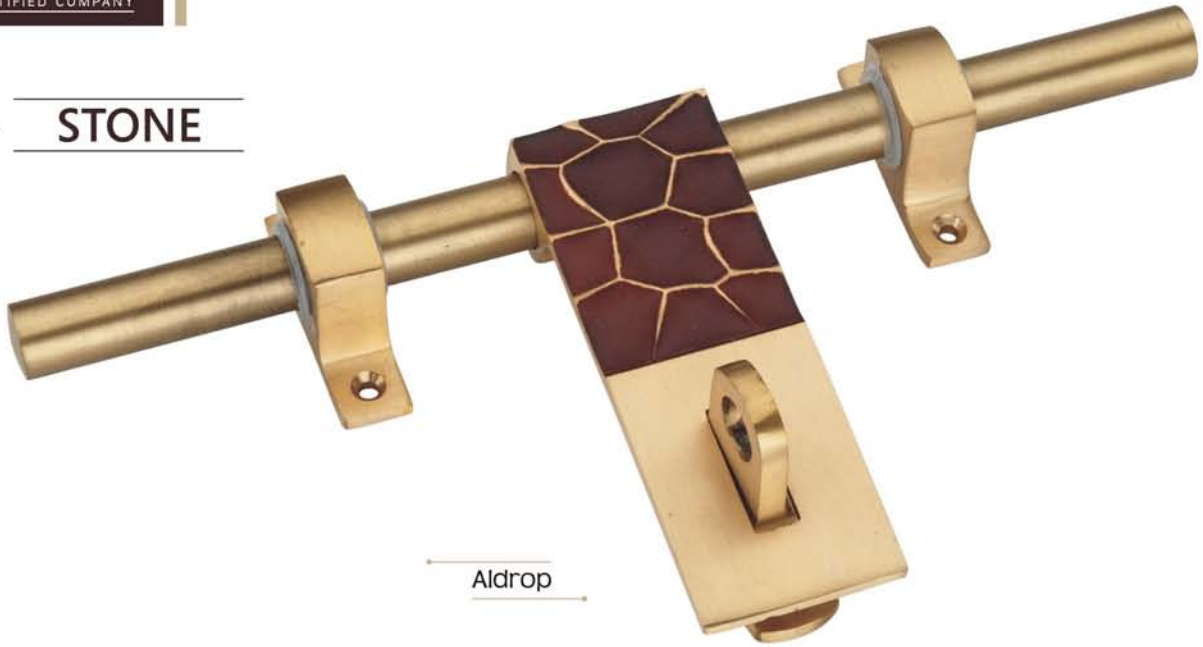

Aldrop



Latch
12mm

MATERIAL
Brass

ROD THICKNESS
AVL. IN SS ROD ONLY
12, 16mm

FINISH
SS & Antique

FUNCTION
Indoor & Outdoor

Door Thickness : 37mm upto 80mm
Application : Hotel, Residential, Office
Suitable for : Wooden main doors



Stopper
125mm



Handle
175, 150mm



Con. Handle
225, 275mm

MESH

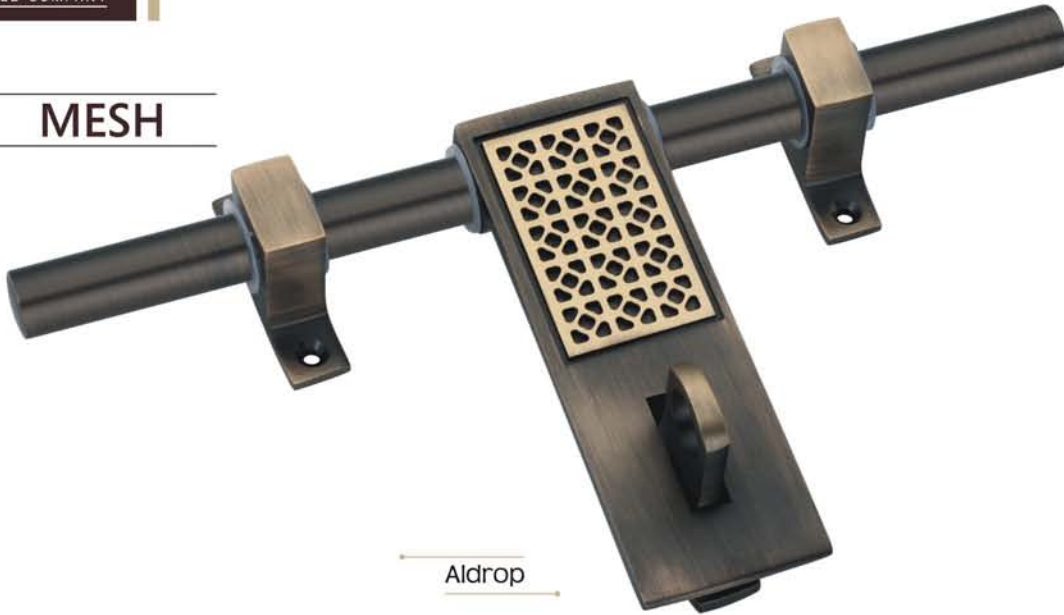

Aldrop



Latch
12mm

MATERIAL
Brass

ROD THICKNESS
AVL. IN SS ROD ONLY
16mm

FINISH
Antique

FUNCTION
Indoor & Outdoor

Door Thickness : 37mm upto 80mm
Application : Hotel, Residential, Office
Suitable for : Wooden main doors



Stopper
125mm



Handle
150mm



Con. Handle
200mm

TRAP



Aldrop



MATERIAL
Brass



ROD THICKNESS
16mm



FINISH
Antique



FUNCTION
Indoor & Outdoor



Door Thickness : 37mm upto 80mm
Application : Hotel, Residential, Office
Suitable for : Wooden main doors

Latch
12mm



Stopper
125mm



Handle
150mm



Con. Handle
200mm

BRASS MORTISE HANDLE

The geometry of historic architecture is brought back to life in this harmonious collection, where the neck of the handle develops like a flower opening and a large petals forms the handgrip itself.

MADE IN INDIA

CENT
AN ISO CERTIFIED COMPANY



WE CARE FOR
YOUR DREAM HOME



MUGHAL

Door Thickness : 37-50mm
 Application : Hotel, Residential, Office
 Suitable for : Wooden main doors



MATERIAL
Forged Brass

SIZE
325mm

FINISH
Brass Antique

FUNCTION
Indoor & Outdoor



HERITAGE

Door Thickness : 37-50mm
 Application : Hotel, Residential, Office
 Suitable for : Wooden main doors



MATERIAL
Forged Brass

SIZE
325mm

FINISH
Brass Antique

FUNCTION
Indoor & Outdoor



ALFA

Door Thickness : 37-50mm
Application : Hotel, Residential, Office
Suitable for : Wooden main doors



MATERIAL
Forged Brass

SIZE
300mm

FINISH
Brass Antique

FUNCTION
Indoor & Outdoor



TAJ

Door Thickness : 37-50mm
Application : Hotel, Residential, Office
Suitable for : Wooden main doors



MATERIAL
Forged Brass

SIZE
225, 275mm

FINISH
Brass Antique

FUNCTION
Indoor & Outdoor

SARTAJ



Door Thickness : 37-50mm
Application : Hotel, Residential, Office
Suitable for : Wooden main doors



MATERIAL
Forged Brass

SIZE
275mm

FINISH
Brass Antique

FUNCTION
Indoor & Outdoor

HUT



Door Thickness : 37-50mm
Application : Hotel, Residential, Office
Suitable for : Wooden main doors



MATERIAL
Forged Brass

SIZE
250mm

FINISH
Brass Antique

FUNCTION
Indoor & Outdoor

ELIANA



Door Thickness : 37-50mm
Application : Hotel, Residential, Office
Suitable for : Wooden main doors



MATERIAL
Forged Brass

SIZE
275mm

FINISH
Ant., SS, FSG

FUNCTION
Indoor & Outdoor



KRISH

Door Thickness : 37-50mm
Application : Hotel, Residential, Office
Suitable for : Wooden main doors



MATERIAL
Forged Brass

SIZE
275mm

FINISH
Ant., SS, FSG

FUNCTION
Indoor & Outdoor



CROWN

Door Thickness : 37-50mm
Application : Hotel, Residential, Office
Suitable for : Wooden main doors



MATERIAL
Forged Brass

SIZE
275mm

FINISH
Ant., SS, FSG

FUNCTION
Indoor & Outdoor



ORCHID

Door Thickness : 37-50mm
Application : Hotel, Residential, Office
Suitable for : Wooden main doors



MATERIAL
Forged Brass

SIZE
275mm

FINISH
Ant., SS, FSG

FUNCTION
Indoor & Outdoor

LEGO



Door Thickness : 37-50mm
Application : Hotel, Residential, Office
Suitable for : Wooden main doors



 MATERIAL
Forged Brass

 SIZE
200, 275mm

 FINISH
Ant., SS, FSG

 FUNCTION
Indoor & Outdoor

EXTER



Door Thickness : 37-50mm
Application : Hotel, Residential, Office
Suitable for : Wooden main doors



 MATERIAL
Forged Brass

 SIZE
200, 275mm

 FINISH
Ant., SS, FSG

 FUNCTION
Indoor & Outdoor

ZION



Door Thickness : 37-50mm
Application : Hotel, Residential, Office
Suitable for : Wooden main doors



 MATERIAL
Forged Brass

 SIZE
200, 275mm

 FINISH
Ant., SS, FSG

 FUNCTION
Indoor & Outdoor

ELEVATE



Door Thickness : 37-50mm
Application : Hotel, Residential, Office
Suitable for : Wooden main doors



 MATERIAL
Forged Brass

 SIZE
200, 275mm

 FINISH
Ant., SS, FSG

 FUNCTION
Indoor & Outdoor



 MATERIAL
Forged Brass

 SIZE
250, 325mm

 FINISH
SS, Ant., FSG

DIVINE



 MATERIAL
Forged Brass

 SIZE
175, 200, 250mm
62mm Rose

 FINISH
SS, Ant., FSG

ICON



 MATERIAL
Forged Brass

 SIZE
175, 200, 250mm
62mm Rose

 FINISH
SS, Ant., FSG

FISTA



 MATERIAL
Forged Brass

 SIZE
200, 275mm
62mm Rose

 FINISH
SS, Ant., FSG

LACY



MATERIAL
Forged Brass

SIZE
200, 250mm

FINISH
SS, Ant., FSG

SUPER STAR



MATERIAL
Forged Brass

SIZE
200, 275mm

FINISH
SS, Ant., FSG

RANA



MATERIAL
Forged Brass



SIZE
175, 200, 250mm

FINISH
SS, Ant., FSG

ROBO



MATERIAL
Forged Brass



SIZE
200, 275mm

FINISH
SS, Ant., FSG

SAMI



KY



MATERIAL
Forged Brass



SIZE
125, 175mm



FINISH
SS, Ant., FSG

CF - 336



CY



MATERIAL
Forged Brass



SIZE
175mm



FINISH
SS, Ant., FSG

IMPERIAL



CY



KY



MATERIAL
Forged Brass



SIZE
125, 175, 200
250mm



FINISH
SS, Ant., FSG

FLATO



KY



MATERIAL
Forged Brass



SIZE
175mm



FINISH
SS, Ant., FSG

DAISY

BRASS ROSE HANDLE

A collection that radically changes aspect depending on the point of view, transforming itself into classic and modern, thus managing to be in perfect harmony with the surrounding furniture.

MADE IN INDIA

CENT
AN ISO CERTIFIED COMPANY



MAGICAL **WAYS** OF
CREATING **EXCELLENCE**



ZION



MATERIAL
Brass



SIZE
62mm



FINISH
SS, Ant., Black



LEGO



MATERIAL
Brass



SIZE
62mm



FINISH
SS, Ant., Black



EXTER



MATERIAL
Brass



SIZE
62mm



FINISH
SS, Ant., Black



ELEVATE



MATERIAL
Brass



SIZE
62mm



FINISH
SS, Ant., Black



MARS



MATERIAL
Brass



SIZE
62mm



FINISH
SS, Ant., Black



SUNNY



MATERIAL
Brass



SIZE
62mm



FINISH
SS, Ant., Black



CORAL



MATERIAL
Brass



SIZE
62mm



FINISH
SS, Ant., Black



CAMILA



MATERIAL
Brass



SIZE
62mm



FINISH
SS, Ant., Black



ZINC & SS MORTISE
HANDLE

DESIRE
MEETS A VALUE



SS

CSZM-001



MATERIAL
Zinc & SS



SIZE
200, 250mm



FINISH
SS, Ant. & Black



SS

CSZM-002



MATERIAL
Zinc & SS



SIZE
200, 250mm



FINISH
SS, Ant. & Black



SS

CSZM-004



MATERIAL
Zinc & SS



SIZE
200, 250mm



FINISH
SS, Ant. & Black



SS

CSZM-005



MATERIAL
Zinc & SS



SIZE
200, 250mm



FINISH
SS, Ant. & Black



Antique

CSZM-006



MATERIAL
Zinc & SS



SIZE
200, 250mm



FINISH
SS, Ant. & Black



Antique

CSZM-007



MATERIAL
Zinc & SS



SIZE
200, 250mm



FINISH
SS, Ant. & Black



Antique

CSZM-008



MATERIAL
Zinc & SS



SIZE
200, 250mm



FINISH
SS, Ant. & Black



Antique

CSZM-009



MATERIAL
Zinc & SS



SIZE
200, 250mm



FINISH
SS, Ant. & Black



SS

CSZM-011



MATERIAL
Zinc & SS



SIZE
200, 250mm



FINISH
SS, Ant. & Black



SS

CSZM-013



MATERIAL
Zinc & SS



SIZE
200, 250mm



FINISH
SS, Ant. & Black



SS

CSZM-015



MATERIAL
Zinc & SS



SIZE
200, 250mm



FINISH
SS, Ant. & Black



SS

CSZM-016



MATERIAL
Zinc & SS



SIZE
200, 250mm



FINISH
SS, Ant. & Black



Antique

CSZM-017



MATERIAL
Zinc & SS



SIZE
200, 250mm



FINISH
SS, Ant. & Black



Antique

CSZM-021



MATERIAL
Zinc & SS



SIZE
200, 250mm



FINISH
SS, Ant. & Black



Antique

CSZM-022



MATERIAL
Zinc & SS



SIZE
200, 250mm



FINISH
SS, Ant. & Black



Antique

CSZM-023



MATERIAL
Zinc & SS



SIZE
200, 250mm



FINISH
SS, Ant. & Black



SS

CSZM-026



MATERIAL
Zinc & SS



SIZE
200, 250mm



FINISH
SS, Ant. & Black



SS

CSZM-027



MATERIAL
Zinc & SS



SIZE
200, 250mm



FINISH
SS, Ant. & Black



SS

CSZM-028



MATERIAL
Zinc & SS



SIZE
200, 250mm



FINISH
SS, Ant. & Black



SS

CSZM-029



MATERIAL
Zinc & SS



SIZE
200, 250mm



FINISH
SS, Ant. & Black





CAM-043

-  MATERIAL
Aluminium
-  SIZE
200mm
-  FINISH
SS & Antique



CAM-044

-  MATERIAL
Aluminium
-  SIZE
200mm
-  FINISH
SS & Antique



CAM-045

-  MATERIAL
Aluminium
-  SIZE
200mm
-  FINISH
SS & Antique



CAM-046

-  MATERIAL
Aluminium
-  SIZE
200mm
-  FINISH
SS & Antique





CAM-047

-  MATERIAL
Aluminium
-  SIZE
200mm
-  FINISH
SS & Antique



CAM-048

-  MATERIAL
Aluminium
-  SIZE
200mm
-  FINISH
SS & Antique





CIM-71

-  MATERIAL
Mild Steel
-  SIZE
175mm
-  FINISH
SS & Antique



CIM-72

-  MATERIAL
Mild Steel
-  SIZE
175mm
-  FINISH
SS & Antique



CIM-73

-  MATERIAL
Mild Steel
-  SIZE
175mm
-  FINISH
SS & Antique



CIM-74

-  MATERIAL
Mild Steel
-  SIZE
175mm
-  FINISH
SS & Antique





CIM-75

-  MATERIAL
Mild Steel
-  SIZE
175mm
-  FINISH
SS & Antique



CIM-76

-  MATERIAL
Mild Steel
-  SIZE
175mm
-  FINISH
SS & Antique



CSM-115



MATERIAL
SS 202 G.



SIZE
125, 200, 250mm



FINISH
SS & Antique



CSM-116



MATERIAL
SS 202 G.



SIZE
125, 200, 250mm



FINISH
SS & Antique



CSM-117



MATERIAL
SS 202 G.



SIZE
125, 200, 250mm



FINISH
SS & Antique



CSM-118



MATERIAL
SS 202 G.



SIZE
125, 200, 250mm



FINISH
SS & Antique

BRASS PULL HANDLE

Your hand glides over the handle like the wind of the wings of an aeroplane, but the conscious design results in an extremely solid comfortable and secure grip.

MADE IN INDIA

CENT
AN ISO CERTIFIED COMPANY



**ELEGANCE
THAT ELEVATES
YOUR WORLD...**



BLOSSOM



MATERIAL
Brass



SIZE
18", 24", 36"



FINISH
Ant., Gold



DYNAMIC



MATERIAL
Brass



SIZE
14", 18", 24", 36"



FINISH
Ant., Gold



DUNA



MATERIAL
Brass



SIZE
18", 24", 36"



FINISH
Ant., Gold



RAPID



MATERIAL
Brass



SIZE
18", 24", 36"



FINISH
Ant., Rose Gold

SUNFLOWER



MATERIAL
Brass



SIZE
18", 24", 36"



FINISH
Ant., Gold

CUBES



MATERIAL
Brass



SIZE
18", 24", 36"



FINISH
Ant., Gold



PH - 002



MATERIAL
Brass



SIZE
24", 30", 36"



FINISH
Antique



PH - 006



MATERIAL
Brass



SIZE
12" to 36"



FINISH
Antique



TEMPLE



MATERIAL
Brass



SIZE
18", 24", 36"



FINISH
Antique



PYRAMID



VOLVO



UMBRELLA



DYNO



MAHARAJA



MATERIAL
Brass



SIZE
9", 12", 14"
18"



FINISH
Antique



MATERIAL
Brass



SIZE
14", 18"



FINISH
SS, Ant., R/Gold
Black



**LOOK GOOD
LIVE WELL...**

Brass Section Lockable Pull Handle



PHL - 2115



PHL - 2116



PHL - 2117



MATERIAL
Brass



SIZE
15"



FINISH
Ant., Black



Width
(50x8)mm



FUNCTION
Indoor & Outdoor

Brass Section Pull Handle



PH - 101

SIZE (38x6)mm
12", 15", 18", 24"



PH - 102

SIZE (38x8)mm
8", 10", 12", 15", 18", 24"



PH - 103

SIZE (38x8)mm
12", 15", 18", 24"



PH - 104

SIZE (38x6)mm
12", 15", 18", 24"



PH - 105

SIZE (19x6)mm
6", 8", 10", 12", 15", 18"

 MATERIAL
Brass

 FINISH
SS & Ant.

 FUNCTION
Indoor & Outdoor

BDD - 5001



 MATERIAL
Brass

 SIZE
450mm

 FINISH
Antique

 FUNCTION
Indoor & Outdoor

BDD - 5002



 MATERIAL
Brass

 SIZE
450mm

 FINISH
Antique

 FUNCTION
Indoor & Outdoor

ELEGANCE
THAT **ELEVATES**
YOUR **WORLD...**

BETEL



 MATERIAL
Brass

 SIZE
300mm

 FINISH
Antique

 FUNCTION
Indoor & Outdoor

LOTUS



 MATERIAL
Brass

 SIZE
300mm

 FINISH
Antique

 FUNCTION
Indoor & Outdoor

**ELEGANCE
THAT ELEVATES
YOUR WORLD...**



FINISH
BPL, Ant. & SS



MATERIAL
Brass



WINGS

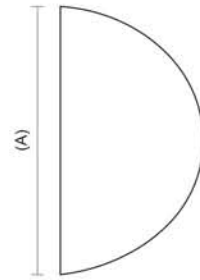

FINISH
Antique

CODE	Size (A)
Wings	300mm



LEXIS

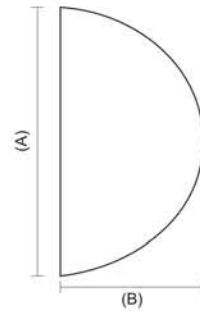

FINISH
Antique

CODE	Size (A)	Size (B)
Lexis	150mm	75mm
Lexis	200mm	100mm
Lexis	250mm	125mm



STONE

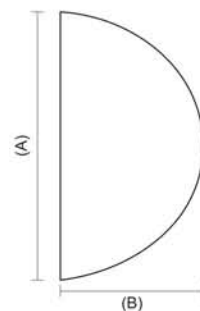

FINISH
Antique

CODE	Size (A)	Size (B)
Stone	150mm	75mm
Stone	200mm	100mm
Stone	250mm	125mm

PYRAMID

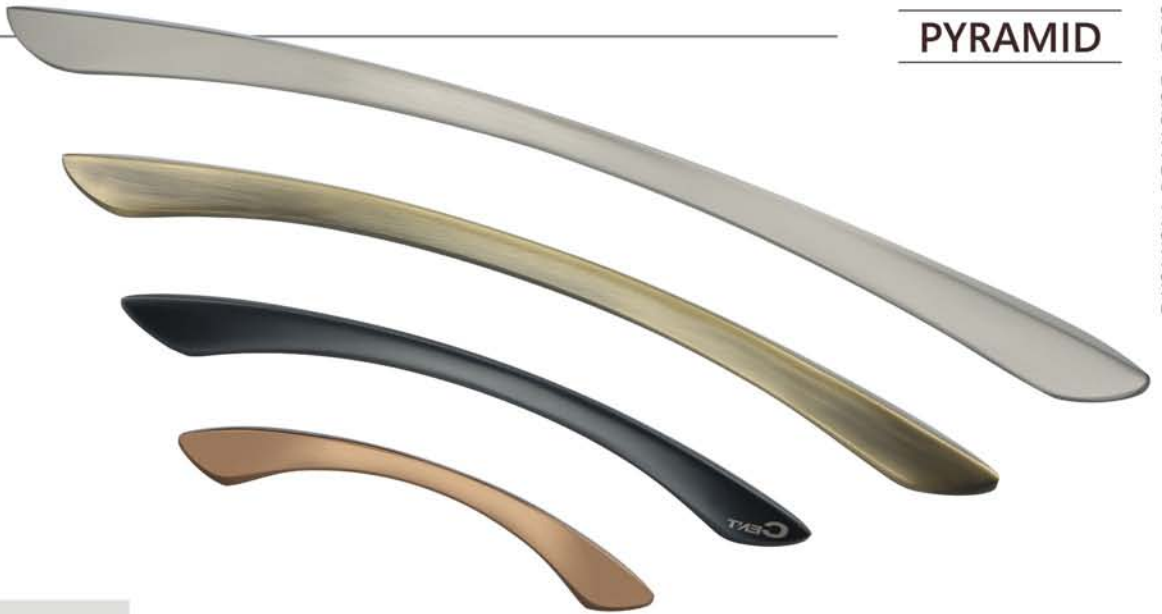

MATERIAL
Brass



SIZE
96, 160, 224, 288mm



FINISH
Ant., SS, Black
R/Gold



FUNCTION
Indoor & Outdoor

VOLVO



MATERIAL
Brass



SIZE
96, 160, 224, 288mm



FINISH
Ant., SS, Black
R/Gold



FUNCTION
Indoor & Outdoor

ZAARA



MATERIAL
Brass



SIZE
96, 160, 224, 288mm



FINISH
Ant., SS, Black
R/Gold



FUNCTION
Indoor & Outdoor

MERCURY



MATERIAL
Brass



SIZE
96, 160, 224, 288mm



FINISH
Ant., SS, Black
R/Gold



FUNCTION
Indoor & Outdoor



SRH - 01



SRH - 03



SRH - 05



SRH - 02



SRH - 04



SRH - 06

 MATERIAL
SS 202 Grade

 SIZE
10", 12", 15", 18", 24"

 FINISH
SS, Antique



Black Matt



Satin Silver



Antique



Black Matt



Satin Silver



Antique



Black Matt



Satin Silver



Antique

CHARLIE

Full Length : 12", 14", 16", 18"
C to C : 10", 12", 14", 16"
Finish : SS, Ant., Black Matt

LOC

Full Length : 12", 14", 16", 18"
C to C : 10", 12", 14", 16"
Finish : SS, Ant., Black Matt

PYTHON

Full Length : 12", 14", 16", 18"
C to C : 10", 12", 14", 16"
Finish : SS, Ant., Black Matt

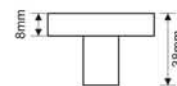
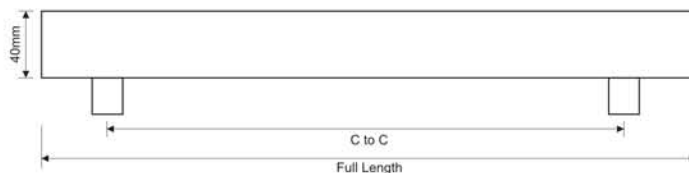

MATERIAL
SS 304 Grade



FINISH
SS, Ant., Black/Matt



FUNCTION
Indoor & Outdoor

CY & KY MORTICE LOCKS

Premium sharp clearly contoured lines and hence soft and pleasant to the touch so perfect and harmonious that there's no need to add anything else.

MADE IN INDIA

CENT
AN ISO CERTIFIED COMPANY

STRENGTH
SECURITY & SAFETY





- MATERIAL MS & Brass
- TYPE Double Turn (65mm)
- FINISH BPL, SS, Ant.



- MATERIAL MS & Brass
- TYPE Double Turn (65mm)
- FINISH BPL, SS, Ant.

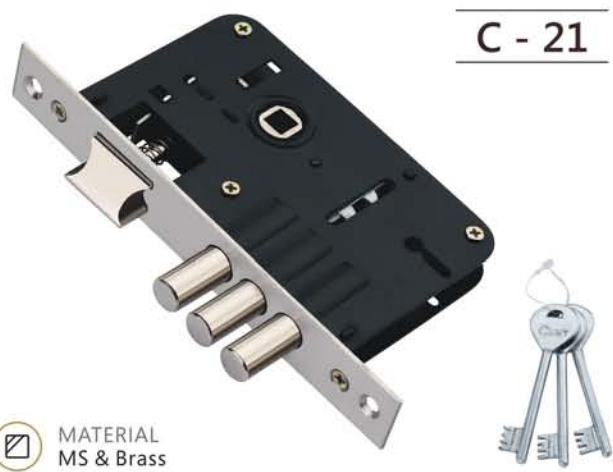

- MATERIAL MS & Brass
- TYPE Double Turn (65mm)
- FINISH BPL, SS, Ant.



- MATERIAL MS & Brass
- TYPE Regular
- FINISH BPL, SS, Ant.



- MATERIAL MS & Brass
- TYPE Regular
- FINISH BPL, SS, Ant.





C - 46

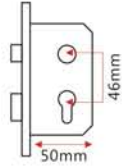

 MATERIAL
MS & Brass

 TYPE
Double Turn (CY)

 FINISH
BPL, SS, Ant.



C - 47

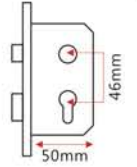

 MATERIAL
MS & Brass

 TYPE
3 Round Bullet (CY)

 FINISH
BPL, SS, Ant.



C - 66

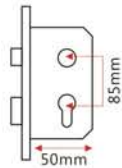

 MATERIAL
MS & Brass

 TYPE
Double Turn (CY)

 FINISH
BPL, SS, Ant.



C - 67

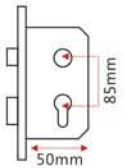

 MATERIAL
MS & Brass

 TYPE
4 Round Bullet (CY)

 FINISH
BPL, SS, Ant.



C - 80

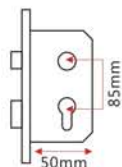

 MATERIAL
MS & Brass

 TYPE
Double Turn (CY)

 FINISH
BPL, SS, Ant.



C - 81

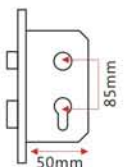

 MATERIAL
MS & Brass

 TYPE
4 Round Bullet (CY)

 FINISH
BPL, SS, Ant.



Brass
Regular Keys



Brass
Ultra Keys

BSK



MATERIAL
Brass



TYPE
Regular & Ultra Keys



FINISH
BPL, Ant., SS



SIZE
60, 70, 80mm



Brass
Regular Keys



Brass
Ultra Keys

OSK



MATERIAL
Brass



TYPE
Regular & Ultra Keys



FINISH
BPL, Ant., SS



SIZE
60, 70, 80mm

HALF CYL



MATERIAL
Brass

SIZE

FINISH
BPL, Ant., SS

COIN CUT



MATERIAL
Brass

SIZE
60, 70, 80mm

FINISH
BPL,
Ant., SS



CMB-41

- 🔧 SIZE : 23, 32mm Brass Cylinder
- 🔑 KEYS: 2 Regular Brass Keys



CMB-43

- 🔧 SIZE : 23, 32mm
- 🔑 KEYS: 2 Wave Brass Keys



CMB-46

- 🔧 SIZE : 23mm
- 🔑 KEYS: 2 Ultra Brass Keys



CMB-50

- 🔧 SIZE : 23mm
- 🔑 KEYS: 2 Ultra Brass Keys



CMB-51

- 🔧 SIZE : 23mm
- 🔑 KEYS: 2 Regular MS Keys



CMB-54

- 🔧 SIZE : 23mm
- 🔑 KEYS: 2 Regular MS Keys



CMB-44

- 🔧 SIZE : 22mm
- 🔑 KEYS: 2 Regular MS Keys



CMB-45

- 🔧 SIZE : 23mm
- 🔑 KEYS: 2 Regular MS Keys



CMB-49

- 🔧 SIZE : 23mm
- 🔑 KEYS: 2 Regular MS Keys

CENT Exclusive



CMB-202

- 🔧 SIZE : 23, 25mm Brass Cylinder
- 🔑 KEYS: 2 Ultra Brass Keys



CMB-55

- 🔧 SIZE : 23, 25mm Zinc Cylinder
- 🔑 KEYS: 2 Ultra Brass Keys



CMB-56

- 🔧 SIZE : 23, 25mm Zinc Cylinder
- 🔑 KEYS: 2 Regular MS Keys

DOOR LOCK SERIES

Behind the scenes we deeply investigate the history of our models and we project them to the future applying the latest technology

CENT
AN ISO CERTIFIED COMPANY



DOOR LOCK

6 STROKE

 MATERIAL
Steel & Brass

 TYPE
CY

 FINISH
SS & Antique

 KEYS
3 Brass Ultra Keys

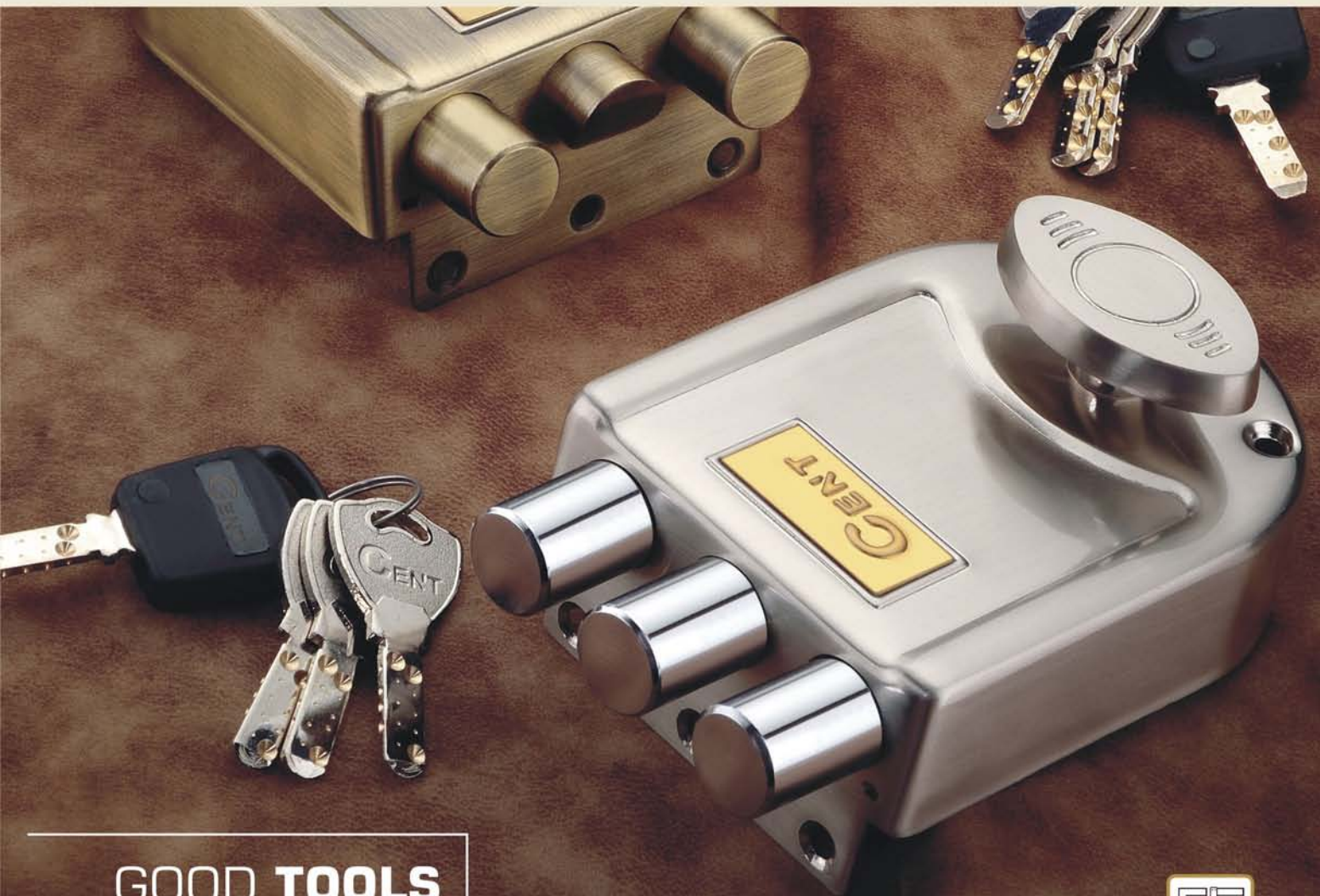

**GOOD TOOLS
FOR GOOD WORK**

MADE IN INDIA





Antique

BOTH SIDE KEY

TRI BOLT
ONE SIDE KEY



MATERIAL
MS & Brass



TYPE
OSK & BSK



FINISH
SS & Ant.



KEYS
3 Ultra Brass Keys + 1 LED Key



Silver Satin

BOTH SIDE KEY

TRI LATCH
ONE SIDE KEY



MATERIAL
MS & Brass



TYPE
OSK & BSK



FINISH
SS & Ant.



KEYS
3 Ultra Brass Keys + 1 LED Key



Antique



RIM LOCK

ONE SIDE KEY



MATERIAL
SS & Brass



TYPE
OSK & BSK



FINISH
SS & Ant.



KEYS
3 Ultra Brass Keys



Silver Satin



ONE SIDE KEY

JIMMY PROOF

BOTH SIDE KEY



MATERIAL
Zinc & Brass



TYPE
OSK & BSK



FINISH
SS & Ant.



KEYS
3 Ultra Brass Keys + 1 LED Key





Satin Silver

BOTH SIDE KEY

HEXA BOLT

BOTH SIDE KEY



MATERIAL
SS & Brass



TYPE
OSK & BSK



FINISH
SS & Ant.



KEYS
4 Ultra Brass Keys



Satin Silver

BOTH SIDE KEY

MEGA BOLT

BOTH SIDE KEY



MATERIAL
Zinc & Brass



TYPE
OSK & BSK



FINISH
SS & Ant.



KEYS
4 Ultra Brass Keys



BRASS DOOR KNOCKER

Decorative art and graphic design sparkling and indian carving trending is both fashionable and of special style.

MADE IN INDIA

CENT
AN ISO CERTIFIED COMPANY



BETTER BY
DESIGN **DEFINE**
BY **STYLE...**





DK - 001

SIZE
150, 200mm



DK - 003

SIZE
200mm



DK - 004

SIZE
200mm



DK - 006

SIZE
150mm



DK - 007

SIZE
150mm



DK - 008

MATERIAL
Forged Brass

FINISH
BPL, Ant., SS, FSG

FUNCTION
Outdoor



GANESH



LEAF GANESH 1



LEAF GANESH 2



LAXMI GANESH



SWASTIK GANESH



SUN



DESIGNER
ARCHITECTURAL
COLLECTION



CBK - 01

SIZE : 2"



CBK - 02

SIZE : 2"



CBK - 03

SIZE : 2"



CBK - 04

SIZE : 2"



CBK - 05

SIZE : 2"



CBK - 06

SIZE : 2"



CBK - 07

SIZE : 2"



CBK - 08

SIZE : 1"



CBK - 09

SIZE : 1"



CBK - 10

SIZE : 1"



CBK - 11

SIZE : 1"



CBK - 12

SIZE : 1"



CBD - 01



-  MATERIAL
Forged Brass
-  SIZE
25 to 75mm
-  FINISH
Ant., SS, FSG

CBD - 02



-  MATERIAL
Forged Brass
-  SIZE
25 to 75mm
-  FINISH
Ant., SS, FSG

CBD - 03



-  MATERIAL
Forged Brass
-  SIZE
25 to 75mm
-  FINISH
Ant., SS, FSG

CBD - 04



-  MATERIAL
Forged Brass
-  SIZE
25 to 75mm
-  FINISH
Ant., SS, FSG

CBD - 05



-  MATERIAL
Forged Brass
-  SIZE
25 to 75mm
-  FINISH
Ant., SS, FSG

CBD - 06



-  MATERIAL
Forged Brass
-  SIZE
25 to 75mm
-  FINISH
Ant., SS, FSG



CT - 01

9mm to 10mm



CT - 02

10mm to 12mm



CT - 04

10mm



CBL - 08

Brass Tower Bolts



CSA - 12

10mm



CSA - 13

10mm

Aluminium Tower Bolts



CH - 01

Brass Gate Hook

TRISHUL



MATERIAL
Brass



ROD THICKNESS
16 & 19mm



FINISH
BPL, ANT. (Matt)



TYPE
Cylindrical Lock 3 Brass Ultra Keys



MAYUR



MATERIAL
Brass



ROD THICKNESS
16 & 19mm



FINISH
BPL, ANT. (Matt)



TYPE
Cylindrical Lock 3 Brass Ultra Keys



Finishes

All Cent products are available in any of our finishes.

All finishes are either electroplated, un-lacquered living finishes or lacquered.

We produce hardware and accessories in a variety
of finishes designed to suit
your every need.



(AB)
Antique Brass



(CA)
Copper Antique



(BRZ)
Bronze



(SS)
Satin Silver



(PC)
Polished Chrome



(PB)
Polished Brass



(PN)
Polished Nickel



(RG)
Rose Gold



(BG)
Brass Gold



(BN)
Black Nickel



(WHT)
White



(MB)
Matt Black

PACKING !

- Auto Polybag Packing
- Auto Labeling
- Auto Instruction Manual Folding
- Auto Strapping Packing





CENT METAL INDUSTRIES

B12-13, Industrial Estate, ITI Road
Aligarh - 202001 (U.P) INDIA

Website : www.centhardware.com
Email : centbrasshardware.neeraj@gmail.com
info@centhardware.com



SCAN ME

we support

